

ELMAS UÇLU ATLAMALI BG DİŞLİ AHŞAP DAİRE TESTERELERİ

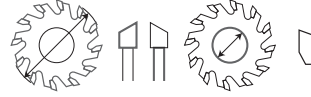

D	B	d	Z
200	3.0	30	20
250	3.2	30	24
300	3.2	30	28
350	3.6	30	32
400	3.8	30	36
400	3.8	30	42
450	4.0	30	42
500	4.0	30	48
550	4.0	30	48
600	4.0	30	56

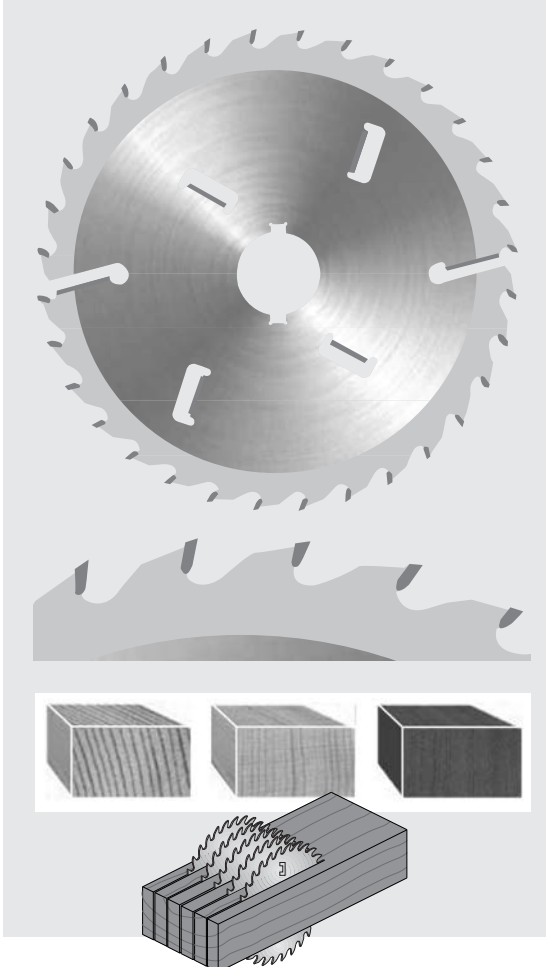

ELMAS UÇLU VE SOĞUTMA BOŞLUKLU ÇOKLU DİLME AHŞAP KESİM

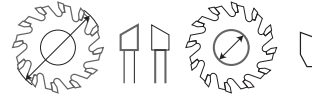

D	B	d	Z
250	2.4	70	24
250	3.2	30	20
250	3.2	60	20
250	3.2	75	20
300	3.4	70	24
300	3.4	75	24
350	3.8	70	28
350	3.8	75	28
350	3.8	75	32
400	3.8	70	32
450	4	70	36

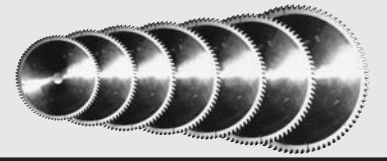

TRF DİŞLİ ELMAS UÇLU HASSAS KESİM DAİRE TESTERELER

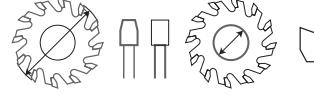

D	B	d	Z	Bileme açıları	
				a	b
180	2.4	30	58	6	15
190	2	30	58	5	18
200	3.0	30	48	6	15
200	3.0	30	64	5	18
200	2.4	30	64	5	18
200	2	30	64	5	18
220	3.3	30	64	5	18
230	3	30	72	6	15
230	3.3	20	64	6	15
250	3.2	30	60	6	15
250	2	30	80	6	15
250	3.2	30	80	5	18
250	2.4	30	80	5	18
280	3.2	30	64	6	15
300	3.2	30	60	6	15
300	3.2	30	72	6	15
300	3.2	30	96	5	18
300	2	30	96	5	18
350	3.6	30	108	5	18
400	3.8	30	96	12	15
400	3.8	30	120	5	18
450	4.0	30	72	12	15
450	4.0	30	120	5	18
500	4.2	30	120	5	18

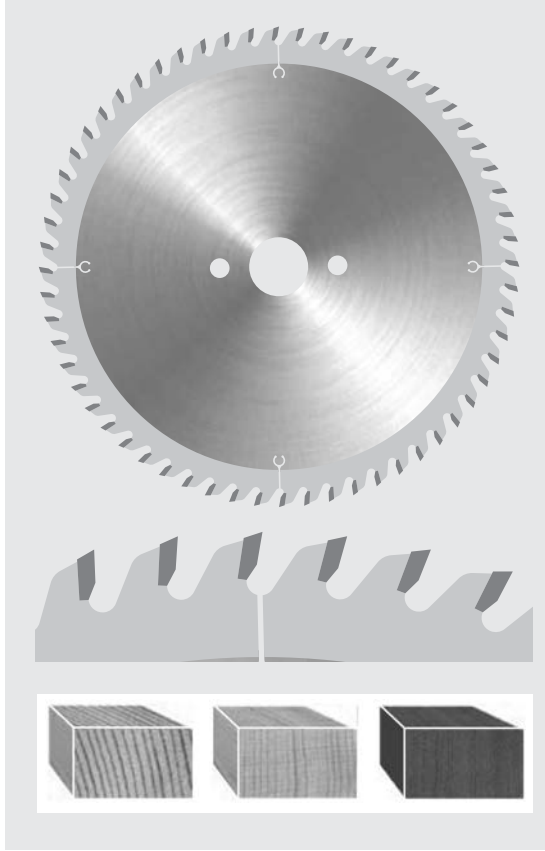

ELMAS UÇLU ÇİZİCİ TESTERELER

Laminant Suntalam ve kaplamalı plakaların kesiminde alt yüzeyden ön çizimi yapılarak kırılmayı önler.

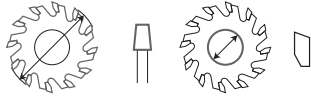

D	B	d	Z
100	2.8-3.8	20	20
120	3.0-4.0	20	24
125	2.8-3.8	20	24
125	3.0-4.0	20	24
125	3.2-4.2	30	24
150	3.0-4.0	20	36
150	3.4-4.4	20	36
150	4.2-5.2	20	36
160	3.0-4.0	30	24
160	4.2-5.2	30	24
180	3.4-4.4	30	24
180	3.0-4.0	30	24
180	4.3-5.3	30	36
200	3.2-4.2	30	34
200	4.2-5.2	30	34
220	3.3	20	64
220	3.0-4.0	20	64

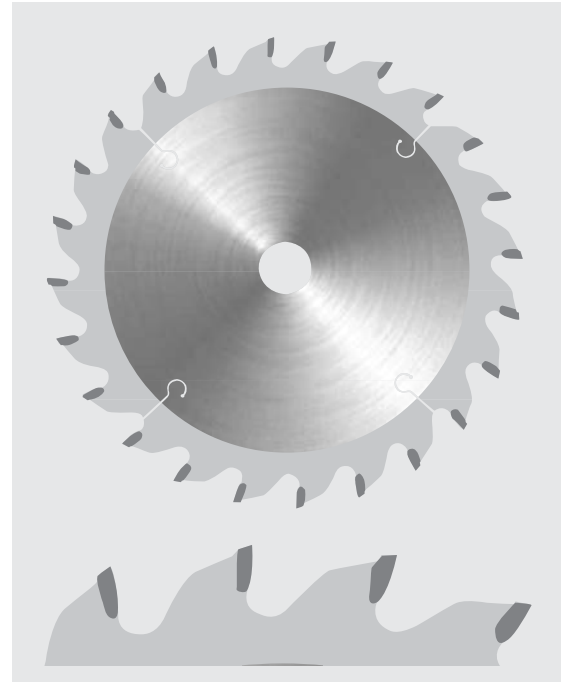



AHŞAP VE SUNTA KESİMİNDE KULLANILAN ELMAS UÇLU DOĞRAMA VE GÖNYELEME TESTERELERİ

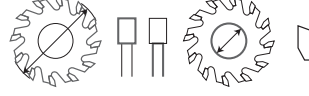
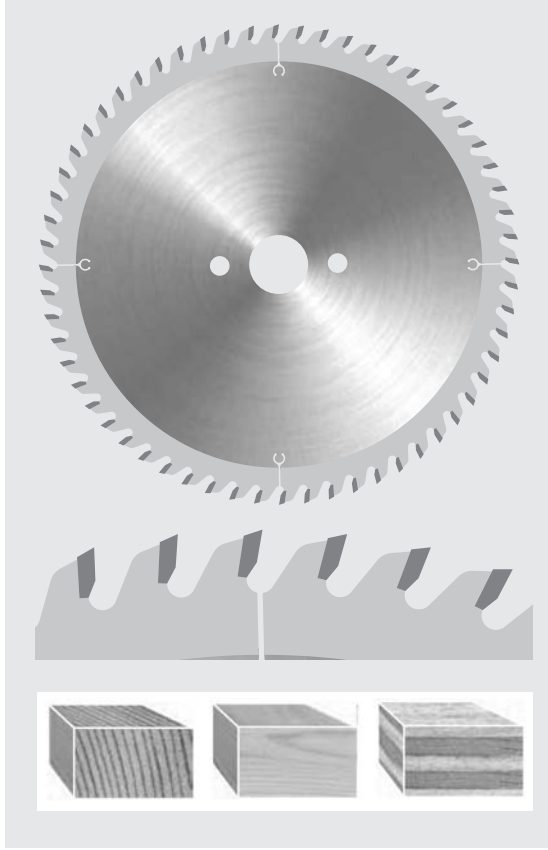

D	B	d	Z	Bileme açıları		
				a	b	c
100	3,0	30	18	10	15	15
150	3,0	30	24	13	15	10
150	3,0	30	48	10	15	15
160	3,0	30	24	13	15	10
160	3,0	30	48	10	15	15
180	3,0	30	24	13	15	10
180	3,0	30	30	13	15	10
180	3,0	30	40	13	15	10
180	3,0	30	48	10	15	15
200	3,0	30	40	13	15	10
200	3,0	30	48	10	15	15
200	3,0	30	64	5	18	15
250	3,2	30	40	13	15	15
250	3,2	30	48	13	15	15
250	3,2	30	60	10	15	15
250	3,2	30	80	5	18	15
300	3,2	30	48	13	15	10
300	3,2	30	60	10	15	15
300	3,2	30	72	10	15	15
300	3,2	30	96	5	18	15
350	3,6	30	54	13	15	10
350	3,6	30	72	13	15	15
350	3,6	30	84	10	15	15
350	3,6	30	108	5	18	15
400	3,8	30	60	15	15	15
400	3,8	30	72	10	15	15
400	3,8	30	96	10	15	15
400	3,8	30	120	5	18	15
450	4,0	30	54	13	15	10
450	4,0	30	72	13	15	10
450	4,0	30	96	10	15	15
450	4,0	30	120	10	15	15
500	4,0	30	60	10	15	15
500	4,0	30	72	10	15	15
500	4,0	30	96	10	15	15
500	4,0	30	120	10	15	15

MDF-LAMİNAT PANELLERDE KULLANILAN ELMAS UÇLU TESTERELER (KURT AĞIZLI)

Çizici testereye gerek duymadan mükemmel sonuç elde edilerek, çift tarafı lamine edilmiş panelleri kesmede kullanılır



D	B	d	Z	Bileme açıları		
				a	b	c
250	3,2	30	80	Neg2	25	38
300	3,2	30	96	Poz2	25	38
350	3,4	30	108	Poz5	25	38
400	3,8	30	120	Poz5	25	38

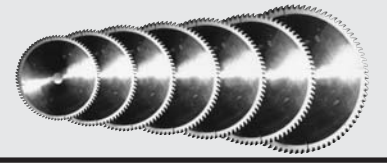

ELMAS UÇLU İNCE MASİF LAMBİRİ VE ÇİTA TESTERELERİ

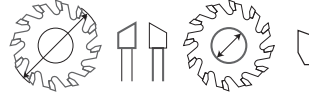
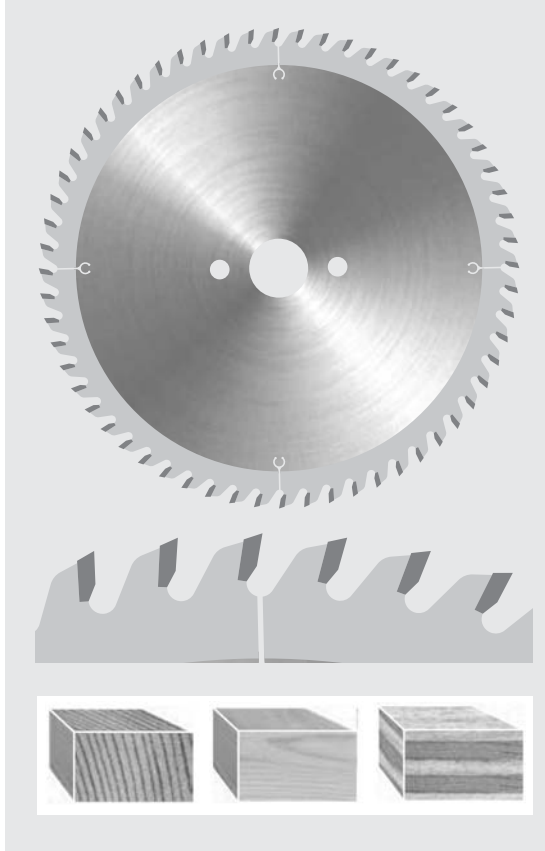

D	B	d	Z	Bileme açıları		
				a	b	c
200	2.4	30	30	15	15	15
200	2.4	30	40	13	15	15
200	2.4	30	64	5	18	15
250	2.4	30	24	18	15	15
250	2.4	30	40	13	15	15
250	2.4	30	48	13	15	15
250	2.4	30	60	10	15	15
250	2.4	30	80	5	18	15
300	2.4	30	28	18	15	15
300	2.4	30	48	15	15	15
350	2.4	30	54	15	15	15

ELMAS UÇLU PORTATİF MAKİNALAR İÇİN DAİRE TESTERELER

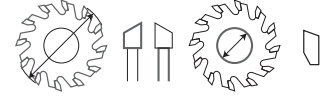
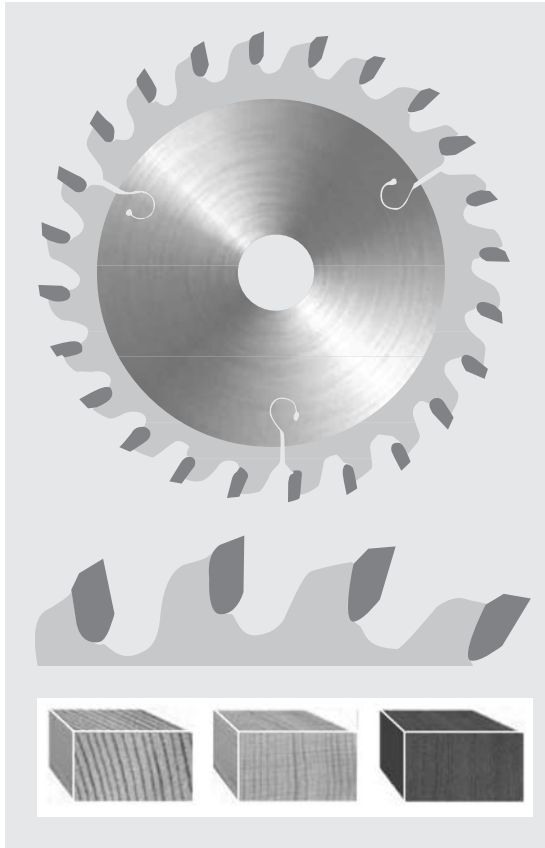

Portatif el makinelerinde sunta, kontrplak kontratable kesiminde ayrıca sert ve yumuşak ağaçların dilimlenmesinde kullanılır.

D	B	d	Z
100	2.4	20	12
110	2.4	20	18
115	2.4	20	12
125	2.4	20	24
127	2.4	20	12
130	2.4	20	24
140	2.4	20	24
150	2.4	20	24
150	2.4	20	48
160	2.4	20	24
165	2.4	20	24
170	2.4	20	24
180	2.4	20	24
180	2.4	20	40
180	2.4	20	48
185	2.4	20	24
185	2.4	20	40
190	2.4	20	24
190	2.4	30	24
190	2.4	20	40
190	2.4	30	40
210	2.4	30	32
210	2.4	30	48
230	2.4	30	36
235	2.4	30	36

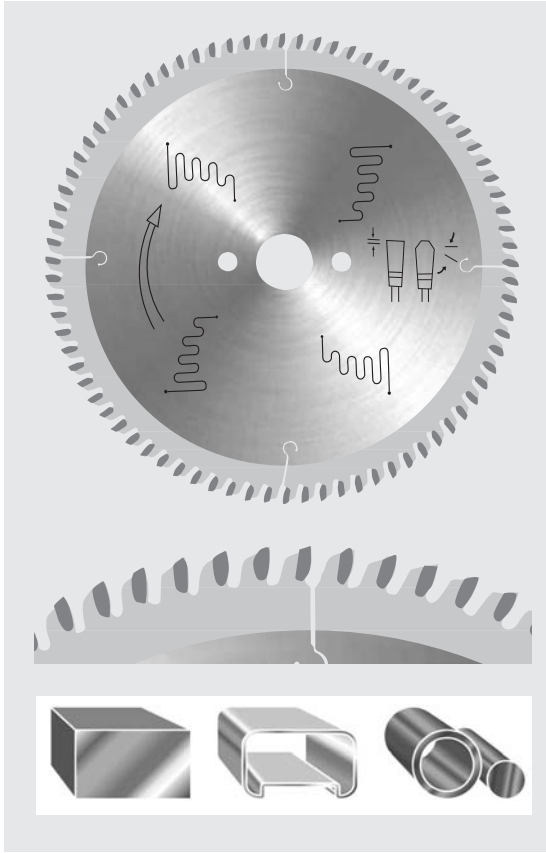
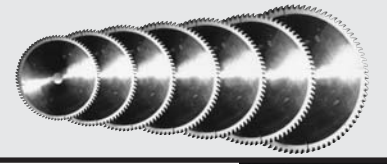

ELMAS UÇLU ALÜMİNYUM VE PVC (SESSİZ) DAİRE TESTERELER

Negatif dişli: Değişik malzeme kalınlıkları olan sac Alüminyum Profil boru ve çubukların kesiminde özellikle kollu makineler için uygundur.

Pozitif dişli: Malzeme kalınlığı 5 mm'den yukarı olan Alüminyum Profil borular ve çubukların kesiminde otomatik makinelerde tavsiye edilir.

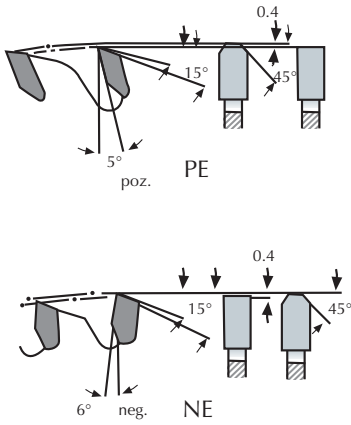
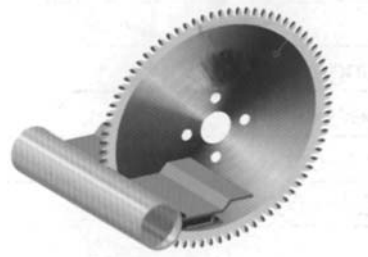

D	B	d	Z	D	B	d	Z
115	4,0	22	20	355	2,0	30	50
140	2,4	30	48	380	3,6	30	56
160	2,2	30	48	380	3,6	32	112
170	3,0	30	48	400	4,0	30	60
180	3,0	30	48	400	4,0	30	72
180	3,0	30	58	400	4,0	30-32	96
190	2,0	30	58	400	4,0	30-32	108
190	3,0	30	58	400	4,0	30-32	120
200	3,0	30	40	400	4,0	30	130
200	3,0	30-32	64	420	4,0	30	72
200	2,0	30-32	64	420	4,0	30-32	96
210	2,0	30	64	420	4,0	30-32	108
230	3,0	30	36	420	4,0	30-32	120
230	3,2	30	72	450	4,0	30	72
235	3,0	30	30	450	4,0	30	96
250	3,2	30-32	60	450	4,0	30-32	108
250	3,2	30-32	80	450	4,0	32	120
250	2,0	30	80	500	4,0	30	60
270	2,4	30	48	500	4,0	30	72
270	3,0	30	88	500	4,0	40	96
275	2,4	30	48	500	4,0	30	108
280	2,5	30	64	500	4,0	30-32	120
280	3,2	30	88	500	4,0	30	140
300	3,2	30	48	500	4,0	30	160
300	3,2	30	60	505	4,0	30	120
300	3,2	30-32	72	550	4,0	50	68
300	3,2	30-32	96	550	4,4	30	72
300	2,0	30-32	96	550	4,4	30	96
305	3,2	30	96	550	4,4	30-32	120
320	3,2	32	96	600	5,0	30	96
330	3,6	32	108	600	5,0	30	120
350	3,6	30-32	84	600	4,4	30	140
350	3,6	30-32	108	600	4,4	30	160

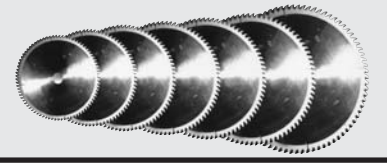

DAİRESEL METAL PROFİL KESME TESTERELERİ

Profil daire testerelerimiz Krom vanadium çeliktan imal edilmiştir. Metal profil malzemelerin kesiminde kullanılır. Kuru kesim.

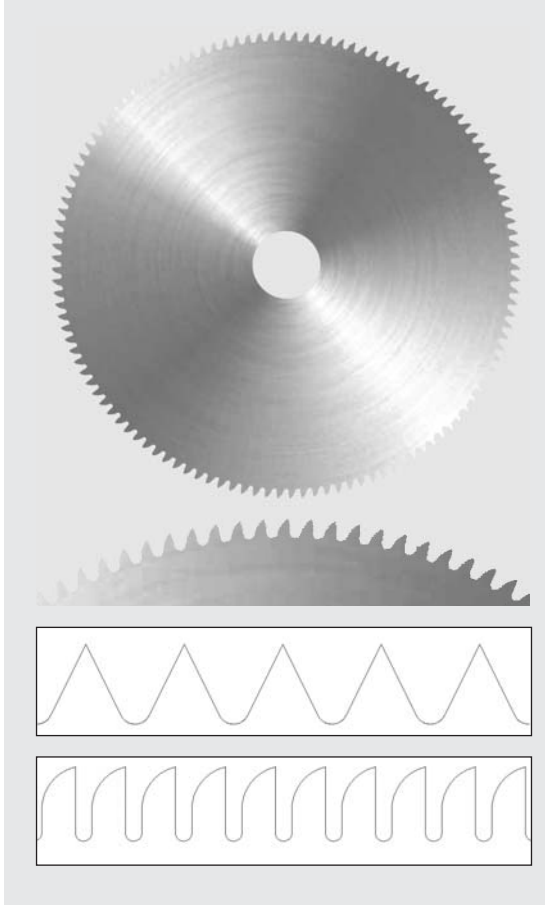

D	B	d	Z	
200	2.0	32	124	
250	2.2	32	156	
250	2.5	32	156	
300	2.5	32	186	
350	2.5	32	216	
400	3.0	40	230	
400	4.0	40	230	
450	3.0	40	260	
450	4.0	40	260	
520	3.0	40	300	
520	4.0	40	300	
520	5.0	40	30	
600	4.0	40	300	
600	5.0	40	240-280-300	
700	5.0	40	280-328-350	
700	6.0	40	280-328-350	
800	5.0	40	320-372-400	
800	6.0	40	320-372-400	
850	6.0	40	340	

KERTME BIÇAKLARI

Alüminyum ve PVC malzemelerde kanal açma işlemlerinde 3'lü takım olarak kullanılır. İsteğe göre her ölçüde kertme bıçakları yapılır.



D	B	d	Z	
86	4.5	30	10	
87	4.3	30	10	
120	5.2	30	14	
127	4.5	30	12	
128	4.5	30	12	
161	5.8	30	18	



BIÇAK AĞIZLI DAİRE TESTERELER (KAĞIT, KUMAŞ İÇİN)

CRV	D	B	d	
	200	2.0	32	
	250	2.2	32	
	250	2.5	32	
	300	2.5	32	
	350	2.5	32	
	400	3.0	40	
	400	4.0	40	
	450	4.0	40	
	520	3.0	40	
	520	4.0	40	
	520	5.0	40	
	600	4.0	40	
	600	5.0	40	

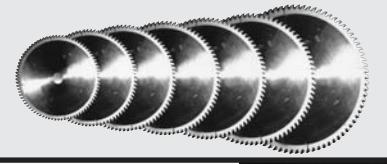

ELMAS UÇLU KANAL TESTERELERİ

Ahşap plakalarda, sert ve yumuşak ağaçlarda istenilen genişlikte kanal ve lamba açma işlemi yapar. Ayrıca masif temizleme işlerinde kullanılır.

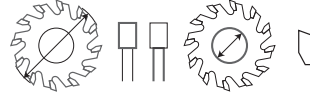

D	B	d	Z
150	4.0	30	12
150	4.0	30	18
150	5.0	30	12
150	5.0	30	18
150	6.0	30	12
150	6.0	30	18
150	8.0	30	12
150	8.0	30	18
150	10.0	30	12
150	10.0	30	18
180	4.0	30	12
180	4.0	30	18
180	5.0	30	12
180	5.0	30	18
180	6.0	30	12
180	6.0	30	18
180	8.0	30	12
180	8.0	30	18
180	9.0	30	12
180	9.0	30	18
180	10.0	30	12
180	10.0	30	18
200	4.0	30	18
200	5.0	30	12
200	6.0	30	12
200	8.0	30	12
200	9.0	30	12
200	9.0	30	18
200	10.0	30	12
200	5.0	30	18
200	6.0	30	18
200	8.0	30	18
200	10.0	30	18

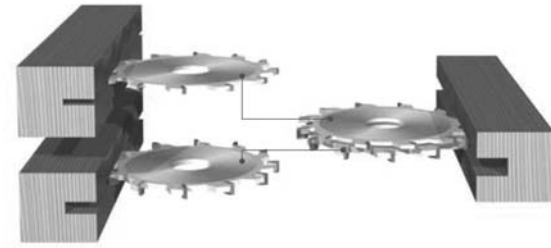

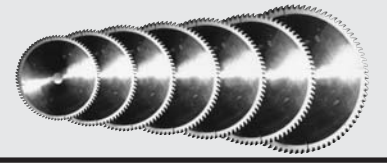

ELMAS UÇLU ALUCOPAN TESTERESİ

Alüminyum kompozit panel kesimi ve istenilen genişlikte kanal açma işleminde kullanılır.

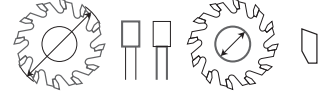
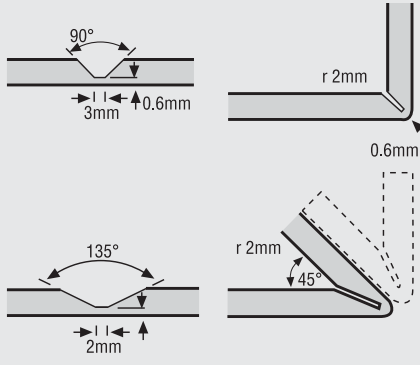
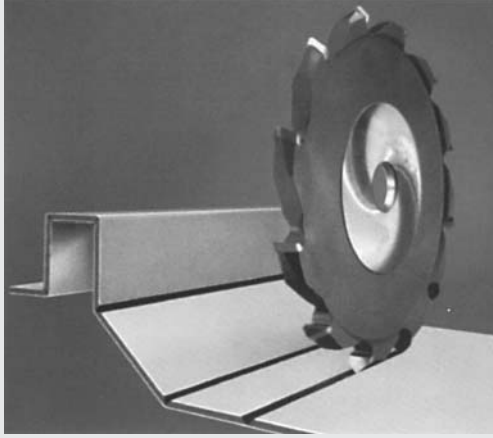

D	B	d	Z
150	8,0	30	18
150	10,0	30	18
180	8,0	30	18
180	8,5	30	18
180	10,0	30	18
180	8,0	30	24
180	10,0	30	24
200	8,0	30	18
200	8,5	30	18
200	10,0	30	18
200	8,0	30	24
200	10,0	30	24

AHŞAP KESİMİNDE KULLANILAN DAİRESEL TESTERELER (ELMASSIZ)

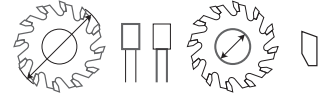
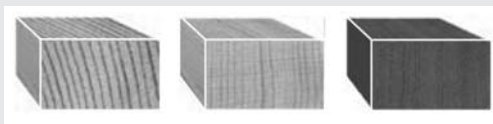

D	B	d	Z
100	0.90	16-20	72
125	0.90	20	72
150	1.0	20	72
175	1.1	20-30	72
200	1.5	30	76
200	3.0	40	72
250	1.5	30	76
250	3.0	40	72
300	1.8	30	76
300	3.0	40	72
350	1.8	30	76
400	2.0	30	76
450	2.2	30	76
500	2.5	30	56
600	2.8	30	56
700	3.5	40	56
800	3.5	40	56

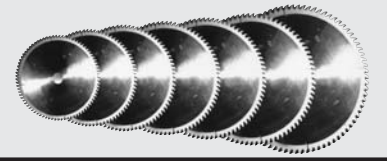

OKSİDASYON VE PVD KAPLAMA HSS DAİRE TESTERELERİ

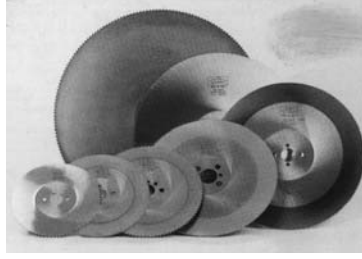

Daire testerenin çelik yapısı bozulmadan kesme performansını artırmak amacı ile testere yüzeyinde 2-5 mikron arasında kesilecek malzeme cinslerine göre çeşitli kaplamalar uygulanmaktadır. Bu yüzey kaplama çeşitleri aşağıda belirtilmiştir.

HSS DMo5 Oksidasyon Kaplama

En yaygın kullanılan yüzey kaplamalı testere olup, testere yüzeyine yağlamadan ötürü kendinden oluşan demir oksit tabaka yani kontrollü oksidasyondur PVD değildir. Genellikle demir, bakır, pirinç ve diğer genel metallerin kesiminde kullanılır.

Yüzey sertliği: 500 HV

TICN Kaplama

Mükemmel kesim performansına sahip olup, kesim ve besleme hızında diğer oksidasyon kaplama testere nazaran %100'den fazla kesim hızı ve kalitesi elde etmek mümkündür. Genellikle sert çelikler, bakır ve pirinç alaşım malzemelerin kesimi için iyi sonuçlar verir.

Yüzey sertliği: 3000-3300 HV

TIAIN Kaplama

Özellikle paslanmaz, dökme demir, silikon alüminyum alaşım malzeme ve bakır gibi kesimler için çok iyi sonuçlar verip kesme maliyetini en asgariye düşürür.

Yüzey sertliği: 3300-3500 HV

Çap Kalınlık	Siyah	TICN-RED	TIAIN	Çap Kalınlık	Siyah	TICN-RED	TIAIN
200x1,5-1,6				315x2,5			
200x1,8				315x3,0			
200x2,0				325x2,0			
210x2,0				325x2,5			
225x1,5-1,6				350x2,0			
225x1,8				350x2,5			
225x1,9-2,0				350x3,0			
250x1,2				370x3,0			
250x1,5-1,6				400x3,0			
250x2,0				400x3,5			
250x2,5				400x4,0			
275x1,6				425x3,0			
275x2,0				425x3,5			
274x2,5				425x4,0			
300x1,6				450x3,0			
300x2,0				450x3,5			
300x2,5				450x4,0			
300x3,0				500x4,0			
315x2,0							

SÖNMEZOĞLU

SÖNMEZOĞLU

TESTERE

TESTERE

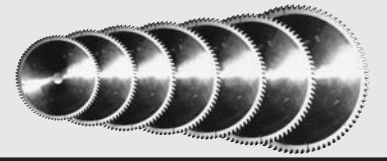

ŞERİT TESTERELER

Bİ METAL M42 ŞERİT TESTERE

ŞERİT EBADI	PARMAKTAKİ DİŞ SAYILARI
6 x 0,90	6 - 8 - 10 - 14 - 10 / 14
10 x 0,90	6 - 8 - 10 - 14 - 10 / 14
13 x 0,65	6 - 8 - 10 - 14 - 8 / 12 - 10 / 14
13 x 0,90	6 - 8 - 10 - 14 - 8 / 12 - 10 / 14
20 x 0,90	4 - 6 - 8 - 10 - 14 - 6 / 10 - 8 / 12 - 10 / 14
27 x 0,90	3 - 4 - 6 - 8 - 14 - 2 / 3 / 4 / 6 / 5 / 8 - 6 / 10 - 10 / 14
34 x 1,10	3 - 4 - 6 - 2 / 3 - 3 / 4 - 4 / 6
41 x 1,30	2 - 3 - 4 - 6 - 2 / 3 - 3 / 4 - 4 / 6
54 x 1,60	2 - 3 - 2 / 3 - 3 / 4
67 x 1,60	2 - 3 - 2 / 3 - 3 / 4

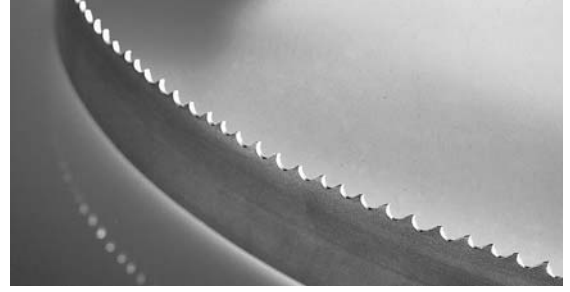
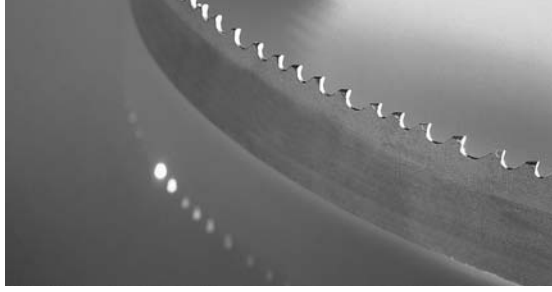

KARBON ÇELİĞİ ŞERİT TESTERE

Ebat	Dış sayısı
4 x 0,65	10 - 14 - 18 - 24
6 x 0,65	10 - 14 - 18 - 24
8 x 0,65	10 - 14 - 18
10 x 0,65	8 - 10 - 14 - 18
13 x 0,65	8 - 10 - 14 - 18
16 x 0,80	6 - 8 - 10 - 14
20 x 0,80	6 - 8 - 10 - 14
25 x 0,90	3 - 4 - 6 - 8 - 10 - 14

AHŞAP İÇİN ŞERİT TESTERELER

ÖLÇÜ	M.MİLLER	WESTA	COBRA
10 x 0.60			
15 x 0.65			
20 x 0.70			
25 x 0.75			
30 x 0.70			
35 x 0.80			
40 x 0.80			
45 x 0.90			
50 x 0.90			
60 x 1.00			
70 x 1.10			
80 x 1.10			
100 x 1.10			
100 x 1.20			
120 x 1.20			
130 x 1.20			
150 x 1.30			

**SÖNMEZOĞLU
TESTERE**





PANEL EBATLAMA TESTERELERİ

MAKİNA	ANA TESTERE					ÇİZİCİ TESTERE					
SF SCHEER	No	Ölçüler			Diş	No	Ölçüler			Diş	
	189201	305 x 3,2 / 2,2 x 30	Z=60	TR-F		188875	200 x 3,2 - 4,1 / 2,2 x 30	Z=60	KO-WS		
	80151192	315 x 3,2 / 2,2 x 30	Z=60	TR-F		188554	200 x 4,4 - 5,2 / 3,2 x 30	Z=36	KO-WS		
	189168	400 x 4,25 / 3,2 x 30	Z=72	TR-F							
	189165	400 x 4,4 / 3,2 x 30	Z=72	TR-F							
HOLZMA	No	Ölçüler			Diş	No	Ölçüler			Diş	
	189173	380 x 4,4 / 3,2 x 60	Z=72	TR-F		188954	180x4,4-5,2/3,2x45	Z=36	KO-WS		
	189170	380 x 4,8 / 3,5 x 60	Z=72	TR-F		188550	180 x 4,8 - 5,6 / 3,5 x 45	Z=36	KO-WS		
	189157	400 x 4,8 / 3,5 x 60	Z=72	TR-F		188556	200x5,8-6,6/4,0x45	Z=36	KO-WS		
	188950	450 x 4,8 / 3,5 x 60	Z=72	TR-F							
Giben	No	Ölçüler			Diş	No	Ölçüler			Diş	
	80140013	320 x 4,4 / 3,2 x 50	Z=60	TR-F		188534	125 x 4,4 - 5,2 / 3,2 x 45	Z=20	KO-WS		
	80198040	350 x 4,4 / 3,2 x 50	Z=72	TR-F		189086	180 x 4,4 - 5,3 / 3,2 x 50	Z=44	KO-WS		
	189184	355 x 4,4 / 3,0 x 75	Z=60	TR-F		188559	215 x 4,4 - 5,2 / 3,2 x 50	Z=42	KO-WS		
	189183	355 x 4,4 / 3,0 x 75	Z=72	TR-F							
	189161	400 x 4,4 / 3,2 x 75	Z=72	TR-F							
	189151	430 x 4,4 / 3,2 x 75	Z=96	TR-F							
SELCO	No	Ölçüler			Diş	No	Ölçüler			Diş	
	189158	400 x 4,4 / 3,2 x 80	Z=72	TR-F		188553	200 x 4,4 - 5,2 / 3,2 x 60	Z=36	KO-WS		
	189149	430 x 4,4 / 3,2 x 80	Z=72	TR-F		188618	200 x 4,8 - 5,6 / 3,5 x 65	Z=36	KO-WS		
	189138	450 x 4,8 / 3,5 x 80	Z=72	TR-F							
GABBANI MACCHINE	No	Ölçüler			Diş	No	Ölçüler			Diş	Fiyat
	189181	355 x 4,4 / 3,0 x 80	Z=72	TR-F		188541	160 x 4,4 - 5,2 x 3,3 x 55	Z=36	KO-WS		
SCM MAYER PANHANS SCHELLING	No	Ölçüler			Diş	No	Ölçüler			Diş	
	189191	350 x 4,4 / 3,0 x 30	Z=72	TR-F		188537	150x4,4-5,2/3,2x20	Z=24	KO-WS		
	189165	400 x 4,4 / 3,2 x 30	Z=72	TR-F		188597	200x4,4-5,2/3,5x20	Z=36	KO-WS		

AHŞAP İÇİN PLANYA BIÇAĞI (WS)

300 x 35 x	3 mm
350 x 35 x	3 mm
400 x 35 x	3 mm
500 x 35 x	3 mm
600 x 35 x	3 mm

ELMAS -HSS PLANYA BIÇAĞI

Malzeme	Yükselik	Kalınlık	HM Elmas Kalınlığı
HSS %18	30-35	x 3	
HM	30x30		10

JİLET BIÇAKLARI

14 x 14 x	2 mm
30 x 12 x	1.5 mm
40 x 12 x	1.5 mm
50 x 12 x	1.5 mm
60 x 12 x	1.5 mm

